

Ball valve with SAE adapter / split flange adapter Steel

MKHP-SAE/SAEFS

Two-way

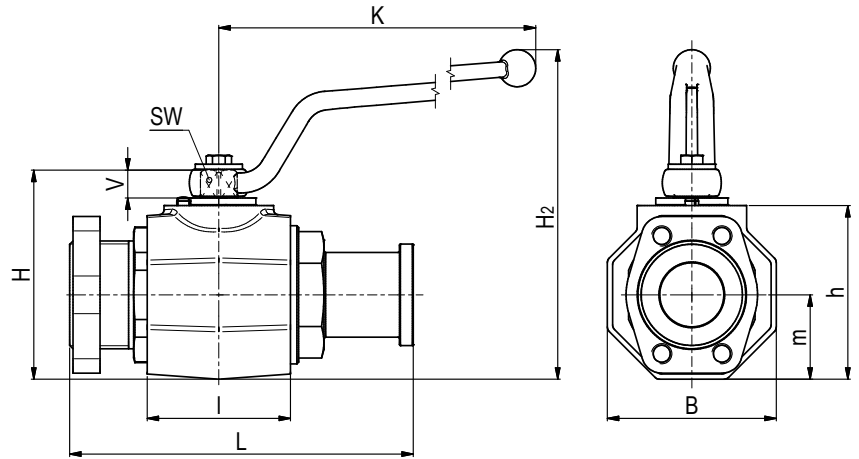

AVAILABLE SIZES

DN32 - DN50 (1 1/4" to 2")

CONNECTIONS

ISO 6162-1, ISO 6162-2

ACCESSORIES ON REQUEST

- Locking devices page 230 - 233
- Actuators 228 - 229
- Mounting holes 26
- Position switches 236 - 237
- Combinations 196 - 197
- Detent on request

MATERIAL CODE DESCRIPTION

Materials	112A	1128
Body	Steel	Steel
Ball	Steel	Steel
Stem	Steel	Steel
Ball seats	POM	POM
O-rings	NBR	FPM
Tmin /Tmax	-20°C / 100°C	-20°C / 100°C

GENERAL DIMENSIONS

Type	l	B 8Kt	H	h	m	V	SW	K	H ₂	Lever
MKHP-DN32	80	81	107	86	40,5	16,5	17	306	180	St
MKHP-DN40	85	100	124	103	50	16,5	17	306	197	St
MKHP-DN50	100	118	138	117	59	16,5	17	306	211	St

Please note the pressure ratings of the connection flanges!

CONNECTION TYPE

ISO 6162-1

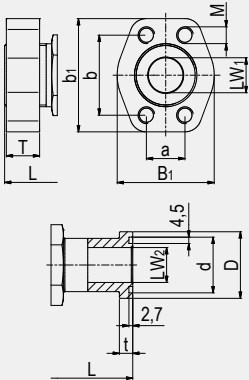

DIMENSIONS

Type	LW ₁	LW ₂	L	B ₁	b ₁	T	a	b	M ⁽¹⁾	d	D	t	Weight [Kg]
MKHP-DN32-SAE210/SAEFS210	32	30	181	68	79	16	30,2	58,7	M10	44,6	50,8	8,1	5,87
MKHP-DN40-SAE210/SAEFS210	38	38	204	78	93	16	35,7	69,9	M12	54,1	60,3	8,1	8,82
MKHP-DN50-SAE210/SAEFS210	48	48	214	90	102	16	42,9	77,8	M12	63,6	71,4	9,6	14,30

ORDER CODE PER MATERIAL COMBINATION

PN [bar]	112A	1128
280	on request	
210	on request	
210	on request	

CONNECTION TYPE

ISO 6162-2

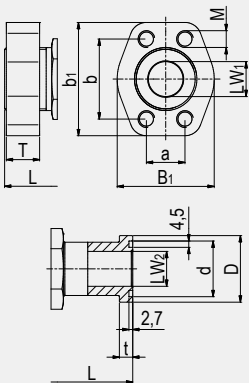

DIMENSIONS

Type	LW ₁	LW ₂	L	B ₁	b ₁	T	a	b	M ⁽¹⁾	d	D	t	Weight [Kg]
MKHP-DN32-SAE420/SAEFS420	32	30	198	78	95	27	31,8	66,7	M12	44,6	54	10,4	6,12
MKHP-DN40-SAE420/SAEFS420	38	38	229	94	112	30	36,5	79,4	M16	54,1	63,5	12,7	9,29
MKHP-DN50-SAE420/SAEFS420	48	48	256	114	134	35	44,5	96,8	M20	63,6	79,4	12,7	15,34

ORDER CODE PER MATERIAL COMBINATION

PN [bar]	112A	1128
420	on request	
420	on request	
420	on request	

⁽¹⁾ UNC threads on request.