

Flow control check valve for piping-system assembly Steel / Stainless Steel

NDRV

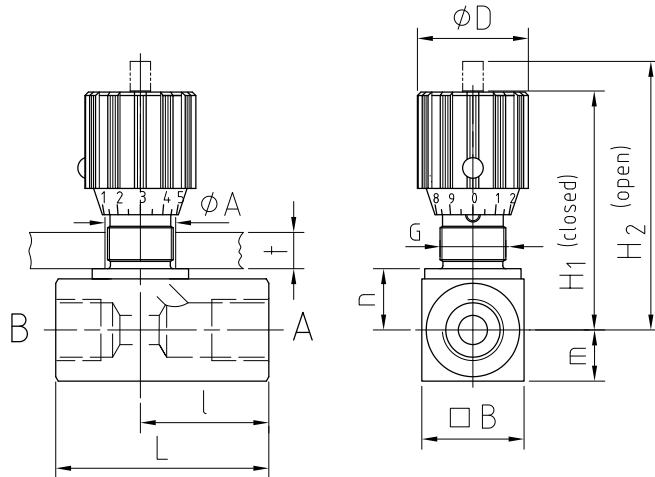

AVAILABLE SIZES

DN6 - DN40 (1/8" to 2")

CONNECTIONS

DIN ISO 228 Female thread,
ANSI B1.20.1 NPT Female thread,
SAE J 514 ISO/DIS 11926-1 Female thread

PORTING PATTERN

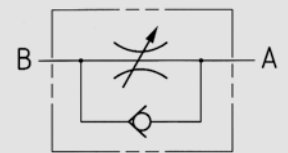

ACCESSORIES ON REQUEST

• Panel mounting kit page 209

MATERIAL CODE DESCRIPTION

Materials	1A	18	4A	48
Body	Steel	Steel	Stainless Steel	Stainless Steel
O-rings	NBR	FPM	NBR	FPM
Tmin /Tmax	-20°C / 100°C	-20°C / 100°C	-30°C / 100°C	-20°C / 100°C
Cracking pressure	0,5 bar*	0,5 bar*	0,5 bar*	0,5 bar*

*Option: Cracking pressure PÖ 4,5 bar

GENERAL DIMENSIONS

Type	H ₁	H ₂	m	n	B	l	L	D	A	G	t _{max}
NDRV-DN6	51	56	8	10	16	26	45	24	13	Pg 7	4
NDRV-DN8	65	71	12,5	14,5	25	33,5	55	29	19	Pg 11	7
NDRV-DN10	68	75	15	17	30	41	65	29	19	Pg 11	7
NDRV-DN12	82	92	17,5	21	35	44	73	38	23	Pg 16	7
NDRV-DN16	96	106	22,5	26	45	57	88	38	23	Pg 16	7
NDRV-DN20	121	134	25	30	50	77	127	49	38	Pg 29	10
NDRV-DN25	126	139	30	35	60	93	143	49	38	Pg 29	10
NDRV-DN30	131	144	35	40	70	91	143	49	38	Pg 29	10
NDRV-DN40	141	154	45	50	90	111	165	49	38	Pg 29	10

! Due to spring and manufacturing tolerances
cracking pressures may deviate by ±30%.

Flow control check valve for piping-system assembly Steel / Stainless Steel

NDRV

CONNECTION TYPE	DIMENSIONS				ORDER CODE PER MATERIAL COMBINATION				
	Type	i	d	Weight [Kg]	PN [bar]	1A	18	4A	48
 <p>DIN ISO 228 FEMALE THREAD</p>	NDRV-DN6-G1/8	9,5	G1/8	0,10	350	26868*	30690*	37675	37676
	NDRV-DN8-G1/4	13,5	G1/4	0,30	350	19562*	30652*	10298	09934
	NDRV-DN10-G3/8	13,5	G3/8	0,45	350	21359*	30653*	18568	37677
	NDRV-DN12-G1/2	15,5	G1/2	0,70	350	22829*	30654*	30145	25847
	NDRV-DN16-G3/4	17,5	G3/4	1,26	350	28978*	21586*	15776	31353
	NDRV-DN20-G1	19,5	G1	2,60	350	28977*	29227*	32425	34418
	NDRV-DN25-G1 1/4	21,5	G1 1/4	3,70	350	30086*	30346*	15777	37678
	NDRV-DN30-G1 1/2	23,5	G1 1/2	4,76	350	29494*	31338*	37679	37680
	NDRV-DN40-G2	25,5	G2	8,52	350	30867*	32226*	37681	37682

CONNECTION TYPE	DIMENSIONS				ORDER CODE PER MATERIAL COMBINATION				
	Type	i	d	Weight [Kg]	PN [bar]	1A	18	4A	48
 <p>ANSI B1.20.1 NPT FEMALE THREAD</p>	NDRV-DN6-1/8"NPT	9,5	1/8"NPT	0,10	350	30993*	37683*	37684	37685
	NDRV-DN8-1/4"NPT	13,5	1/4"NPT	0,30	350	28480*	30558*	37686	26257
	NDRV-DN10-3/8"NPT	13,5	3/8"NPT	0,45	350	24251*	37687*	37688	37689
	NDRV-DN12-1/2"NPT	15,5	1/2"NPT	0,70	350	24519*	37690*	33600	28789
	NDRV-DN16-3/4"NPT	17,5	3/4"NPT	1,26	350	30997*	37691*	30786	32525
	NDRV-DN20-1"NPT	19,5	1"NPT	2,60	350	30998*	37692*	37693	37694
	NDRV-DN25-1 1/4"NPT	21,5	1 1/4"NPT	3,70	350	31000*	37695*	37696	37697
	NDRV-DN30-1 1/2"NPT	23,5	1 1/2"NPT	4,76	350	31001*	37698*	37699	37700
	NDRV-DN40-2"NPT	25,5	2"NPT	8,52	350	31003*	37701*	37702	37703

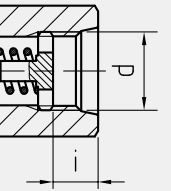
CONNECTION TYPE	DIMENSIONS				ORDER CODE PER MATERIAL COMBINATION				
	Type	i	d	Weight [Kg]	PN [bar]	1A	18	4A	48
 <p>SAE J514/ISO/DIS11926-1 FEMALE THREAD</p>	NDRV-DN8-7/16"UNF	13	7/16"-20 UNF	0,30	350	36102*	36486*	37706	37707
	NDRV-DN10-9/16"UNF	13,5	9/16"-18 UNF	0,46	350	37708*	37709*	37710	37711
	NDRV-DN12-3/4"UNF	15,5	3/4"-16 UNF	0,72	350	37712*	34898*	37713	37714
	NDRV-DN16-1 1/16"UN	20	1 1/16"-12 UN	1,37	350	36068*	37715*	37716	37717
	NDRV-DN20-1 5/16"UN	20	1 5/16"-12 UN	2,66	350	37718	37719	37720	37721
	NDRV-DN25-1 5/8"UN	20	1 5/8"-12 UN	2,86	350	37722	37723	37724	37725
	NDRV-DN30-1 7/8"UN	20	1 7/8"-12 UN	4,45	350	37726	37727	37728	37729
	NDRV-DN40-2 1/2"UN	25,5	2 1/2"-12 UN	8,03	350	37730	37731	37732	37733

Please note the pressure ratings of the tube connections!

*Article usually in stock.

 **Flow control valves should not be used as shut-off device. Small leakage rates may occur in fully closed position. (DIN EN 12266 – leakage rate A-B – test medium water)**

The flow values are valid for hydraulic oil (spissitude 880 kg/m³) and the kinematic viscosity ν of 35 mm²/s.

NDV/NDRV/NDVP/NDRVP-DN6

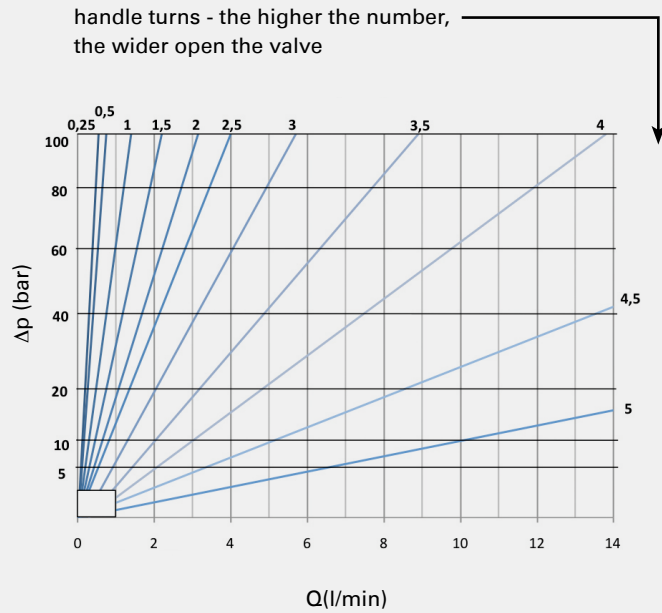

NDV/NDRV/NDVP/NDRVP-DN8

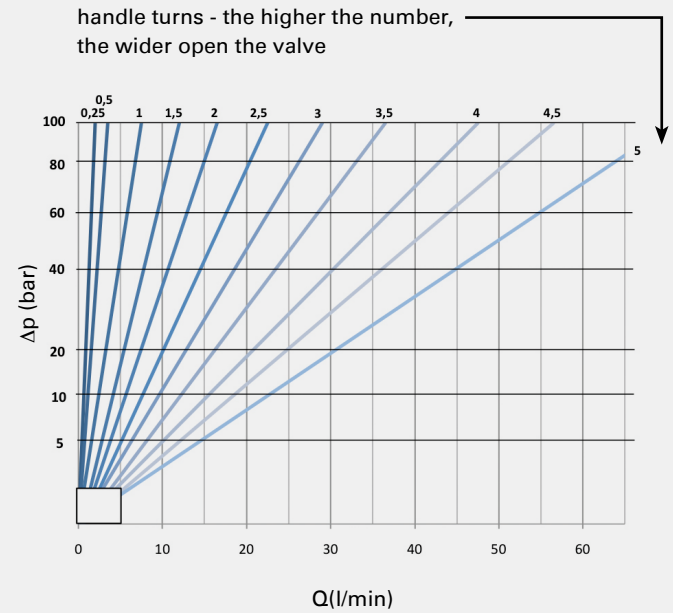

NDV/NDRV/NDVP/NDRVP-DN10

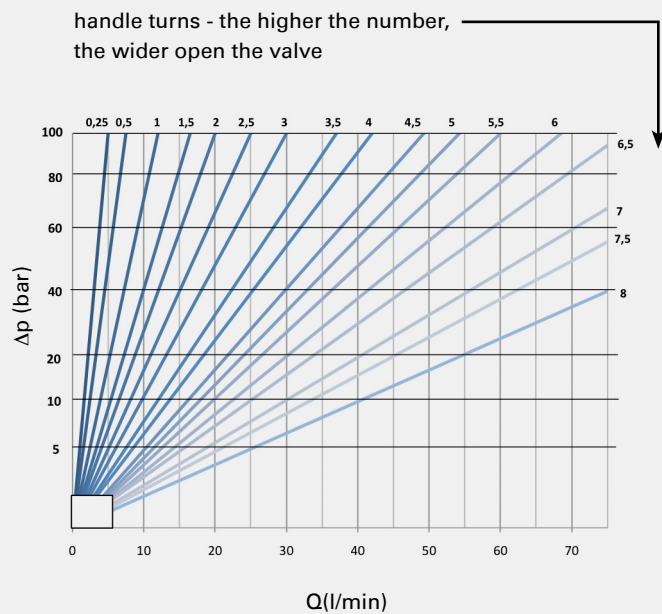

NDV/NDRV/NDVP/NDRVP-DN12

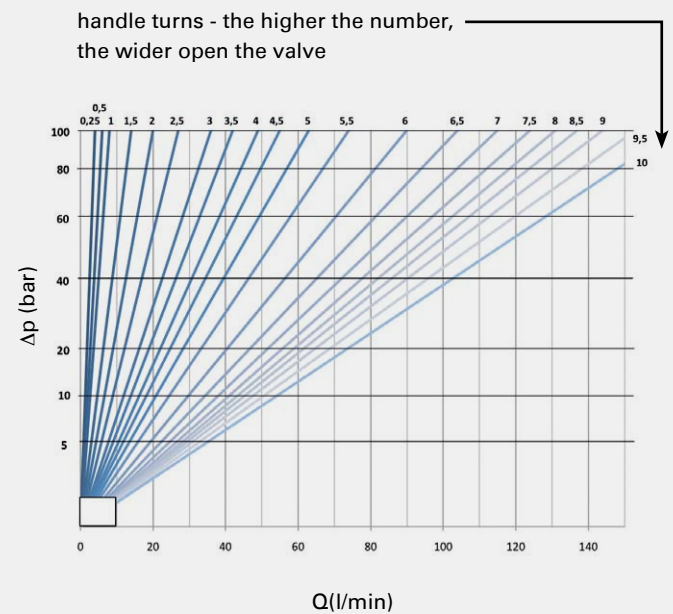

The flow values are valid for hydraulic oil (spissitude 880 kg/m³) and the kinematic viscosity ν of 35 mm²/s.

NDV/NDRV/NDVP/NDRVP-DN16

handle turns - the higher the number, the wider open the valve

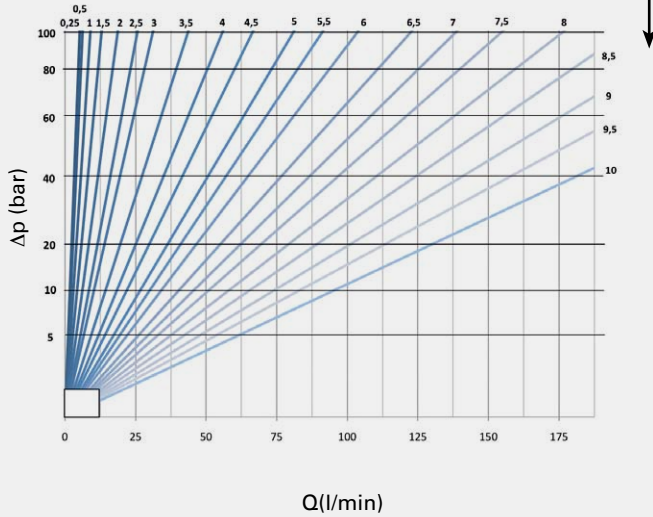

NDV/NDRV/NDVP/NDRVP-DN20/25/30/40

handle turns - the higher the number, the wider open the valve

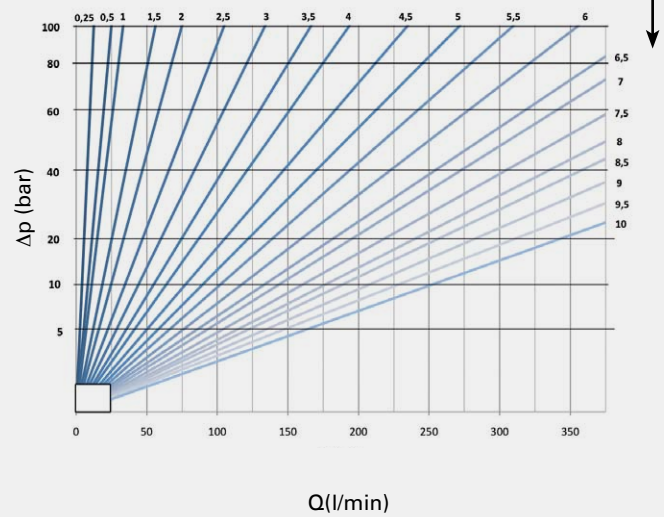

NDRV/NDRVP-DN6 - DN40

Flow direction: B-A

Δp characteristic line free flow through check valve

