

! Pressure inlet only from center port (port 2)!

Multway

AVAILABLE SIZES

DN4 - DN50 (1/8" to 2")

CONNECTIONS

DIN ISO 228 Female thread, ANSI B1.20.1 NPT Female thread, DIN 2353/ISO 8434-1 Light / Heavy series, SAE J 514/ISO/DIS11926-1 Female thread, others on request

ACCESSORIES ON REQUEST

- Locking devices page 230 - 233
- Actuators 228 - 229
- Mounting holes 19
- Position switches 236 - 237
- Combinations 198 - 199
- Detent on request

MATERIAL CODE DESCRIPTION

Materials	112A	112A	1128	1128
Body	Steel	Steel	Steel	Steel
Ball	Steel	Steel	Steel	Steel
Stem	Steel	Steel	Steel	Steel
Ball seats	POM	POM	POM	POM
O-rings	NBR	NBR	FPM	FPM
Tmin /Tmax	-20°C / 100°C	-20°C / 100°C	-20°C / 100°C	-20°C / 100°C
Porting pattern	L=SB50	T=SB51	L=SB50	T=SB51

GENERAL DIMENSIONS

Type	l	b	B	H	h	m	V	SW	K	H ₁	H ₂	Lever
BK3-DN4	40	13	29	47	33	13,5	11	9	115	-	82	Zn
BK3-DN6	40	13	29	47	33	13,5	11	9	115	-	82	Zn
BK3-DN8	40	13	29	47	33	13,5	11	9	115	-	82	Zn
BK3-DN10	43	16	35	52	38	17,5	11	9	115	-	86	Zn
BK3-DN13	48	17,5	38	54	40	19	11	9	115	-	89	Zn
BK3-DN20	62	24,5	52	75	57	24,5	14	14	200	79	-	Zn
BK3-DN25	66	29	61	83	65	29,5	14	14	200	87	-	Zn
BK3-DN25/32	66	29	61	83	65	29,5	14	14	200	87	-	Zn
BK3-DN32	81	39	-	106	84,5	39	16,5	17	320	115	-	Al
BK3-DN40	104	53	-	127	106	53	16,5	17	320	136	-	Al
BK3-DN50	118	58	-	137	116	58	16,5	17	320	146	-	Al

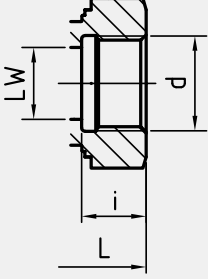
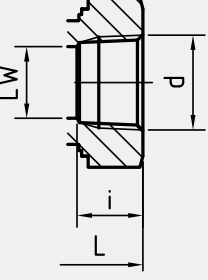
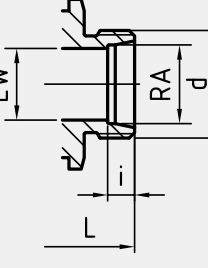
CONNECTION TYPE	DIMENSIONS									ORDER CODE PER MATERIAL COMBINATION				
	Type	LW	L	S	LW ₁	i	d	Weight [Kg]	PN [bar]	112A L=SB50	112A T=SB51	1128 L=SB50	1128 T=SB51	
	BK3-DN4-G1/8	5	69	34,5	4	10	G1/8	0,40	500	02347*	02401*	03236*	03247*	
	BK3-DN6-G1/4	6	69	34,5	6	14	G1/4	0,46	500	02849*	02408*	03237*	03248*	
	BK3-DN10-G3/8	10	72	36	10	14	G3/8	0,60	500	02398*	02413*	03238*	03249*	
	BK3-DN13-G1/2	13	83	41,5	13	16,3	G1/2	0,70	500	02429*	02430*	03239*	03250*	
	BK3-DN13-G5/8	13	83	41,5	13	16	G5/8	0,70	500	02850*	02851*	03240*	03251*	
	BK3-DN20-G3/4	20	95	47,5	20	18	G3/4	1,80	315	02708*	02770*	03241*	03252*	
	BK3-DN25-G1	25	113	56,5	25	20	G1	2,40	315	02711*	02773*	03242*	03253*	
	BK3-DN25/32-G1 1/4	25	120	57	25	22	G1 1/4	2,64	315	02714*	02776*	03243*	03254*	
	BK3-DN32-G1 1/4	30	111	55	30	22	G 1 1/4	4,80	350	32154*	32685*	33571*	38015*	
	BK3-DN40-G1 1/2	38	130	65	38	24	G 1 1/2	8,90	350	31980*	32038*	36033*	38016*	
	BK3-DN50-G2	48	150	75	48	26	G2	12,40	350	38005*	38014*	36034*	38017*	
	BK3-DN4-1/8" NPT	5	69	34,5	4	10,5	1/8" NPT	0,40	500	40221*	40222*	15710*	40223*	
	BK3-DN6-1/4" NPT	6	69	34,5	6	13,7	1/4" NPT	0,46	500	13221*	38049*	11333*	25912*	
	BK3-DN10-3/8" NPT	10	72	36	10	13,5	3/8" NPT	0,60	500	41291*	38050*	11607*	25913*	
	BK3-DN13-1/2" NPT	13	83	41,5	13	17	1/2" NPT	0,70	500	41292*	17198*	11608*	25914*	
	BK3-DN20-3/4" NPT	20	95	47,5	20	18,3	3/4" NPT	1,80	315	15425*	38051*	11609*	25915*	
	BK3-DN25-1" NPT	25	113	56,5	25	21,6	1" NPT	2,40	315	15426*	22926*	11610*	25916*	
	BK3-DN25/32-1 1/4" NPT	25	120	57,5	25	22,1	1 1/4" NPT	2,64	315	38030*	36499*	38032*	25917*	
	BK3-DN32-1 1/4" NPT	30	120	60	30	22,1	1 1/4" NPT	5,24	350	35517*	38052*	36538*	38055*	
	BK3-DN40-1 1/2" NPT	38	140	70	38	22,1	1 1/2" NPT	10,00	350	38031*	38053*	38033*	38056*	
	BK3-DN50-2" NPT	48	150	75	48	30,2	2" NPT	12,20	350	35519*	38054*	38034*	38057*	
		BK3-DN4-6L	5	6	67	33,5	4	7	M 12x1,5	0,30	500	02349*	02403*	03214*
BK3-DN6-8L		6	8	67	33,5	6	7	M 14x1,5	0,40	500	02348*	02402*	03215*	03226*
BK3-DN8-10L		8	10	74	34,5	8	7	M 16x1,5	0,40	500	02396*	02409*	03216*	03227*
BK3-DN10-12L		10	12	74	36,5	10	7	M 18x1,5	0,50	500	02416*	02417*	36116*	03228*
BK3-DN13-15L		13	15	82	41	13	7	M 22x1,5	0,65	500	02425*	02426*	03218*	03229*
BK3-DN13-18L		13	18	82	41,5	13	7,5	M 26x1,5	0,69	500	02847*	02848*	03219*	03230*
BK3-DN20-22L		20	22	101	48	20	7,5	M 30x2	1,50	315	02706*	02768*	03220*	03231*
BK3-DN25-28L		25	28	108	54	25	7,5	M 36x2	2,10	315	02709*	02771*	03221*	03232*
BK3-DN25/32-35L		25	35	112	56	25	10,5	M 45x2	2,50	315	02712*	02774*	03222*	03233*

Please note the pressure ratings of the tube connections!

*Article usually in stock.

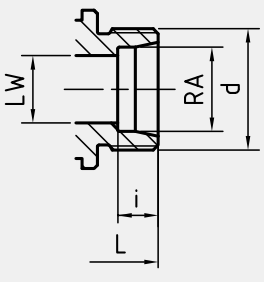
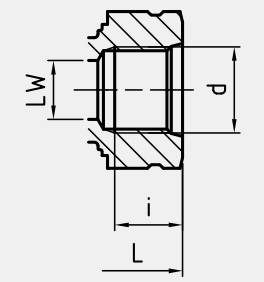
CONNECTION TYPE	DIMENSIONS										ORDER CODE PER MATERIAL COMBINATION				
	Type	LW	RA	L	S	LW ₁	i	d	Weight [Kg]	PN [bar]	112A L=SB50	112A T=SB51	1128 L=SB50	1128 T=SB51	
 DIN 2353 / ISO 8434-1 HEAVY SERIES	BK3-DN4-8S	5	8	73	34,5	4	7	M 16x1,5	0,42	500	02350*	02404*	03194*	03204*	
	BK3-DN6-10S	6	10	73	34,5	6	7,5	M 18x1,5	0,43	500	02351*	02406*	03195*	03205*	
	BK3-DN8-12S	8	12	76	34,5	8	7,5	M 20x1,5	0,44	500	02397*	02410*	03196*	03206*	
	BK3-DN10-14S	10	14	80	36,5	10	8	M 22x1,5	0,50	500	02414*	02415*	03197*	03207*	
	BK3-DN13-16S	13	16	86	43	13	8,5	M 24x1,5	0,65	500	02427*	02428*	03198*	03208*	
	BK3-DN13-20S	13	20	90	43	15	10,5	M 30x2	0,70	500	02845*	02846*	03199*	03209*	
	BK3-DN20-25S	20	25	109	48	20	12	M 36x2	1,70	315	02707*	02769*	03200*	37995*	
	BK3-DN25-30S	25	30	120	57,5	25	13,5	M 42x2	2,40	315	02710*	02772*	03201*	03211*	
	BK3-DN25/32-38S	25	38	124	57,5	25	16	M 52x2	2,80	315	02713*	02775*	03202*	03212*	
	 SAE J514/ISO/DIS11926-1 FEMALE THREAD	BK3-DN6-7/16"UNF	5	69	34,5	12	7/16"-20 UNF	0,50	500	38076*	38094*	38081*	38099*		
BK3-DN10-9/16"UNF		10	72	36	13	9/16"-18 UNF	0,60	500	38077*	38095*	38082*	38100*			
BK3-DN13-3/4"UNF		13	83	41,5	15	3/4"-16 UNF	0,70	500	38078*	38096*	38083*	38101*			
BK3-DN20-1 1/16"UN		20	95	47,5	20	1 1/16"-12 UN	1,80	315	38079*	38097*	11027*	38102*			
BK3-DN25-1 5/16"UN		25	113	56,5	20	1 5/16"-12 UN	2,70	315	38080*	38098*	11026*	38103*			
BK3-DN32-1 5/8"UN		30	111	60	20	1 5/8"-12 UN	5,20	350	39214*	39215*	39216*	39217*			
BK3-DN40-1 7/8"UN		38	140	70	20	1 7/8"-12 UN	10,00	350	39218*	39219*	39220*	39221*			
BK3-DN50-2 1/2"UN		48	150	75	20	2 1/2"-12 UN	12,20	350	39222*	39223*	39224*	39225*			

Please note the pressure ratings of the tube connections!

*Article usually in stock.

Due to material availability the material code of the steel valves may vary from 112A (resp. 1128). DN20-32=812A (8128), DN40-50=212A (2128). Material suitability for the application does not differ from 112A (1128).

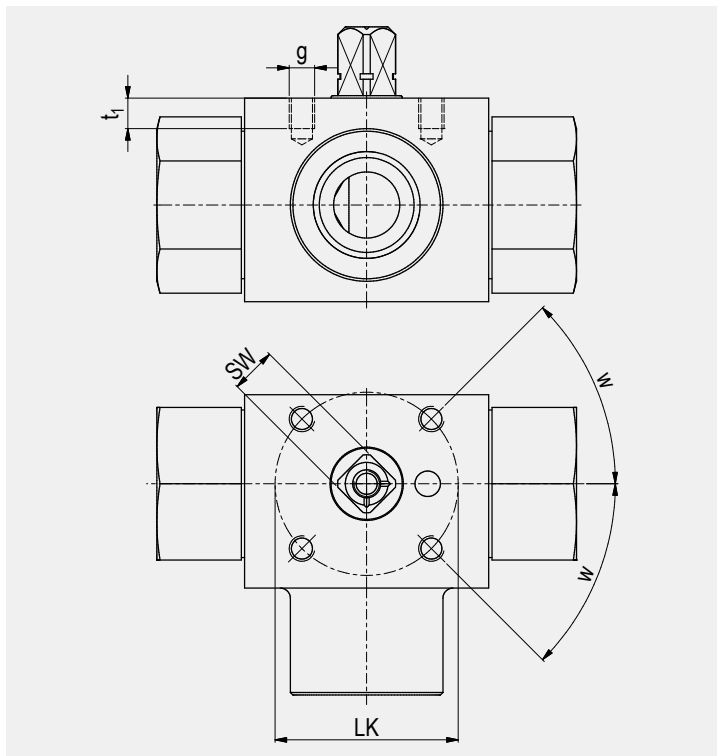

ASSEMBLING THREADS AS PER ISO 5211

DN	SW	LK	g	t ₁	w	ISO 5211
4	9	36	M5	6	30°*	(F03)*
6	9	36	M5	6	30°*	(F03)*
10	9	36	M5	7	45°	F03
13	9	36	M5	6	45°	F03
16	12	42	M5	8	45°	F04
20	14	50	M6	10	45°	F05
25	14	50	M6	10	45°	F05
25/32	14	50	M6	10	45°	F05
25/40	14	50	M6	10	45°	F05

*30° does not correspond to ISO 5211

PORTING PATTERNS

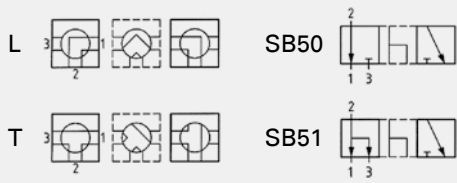

! Pressure inlet only from center port (port 2)!

Further porting patterns page 274 to 279

Please see type BK3-S or 3KH in case you need pressure inlet from all ports.

FLOW CHARACTERISTICS BK3-L/T

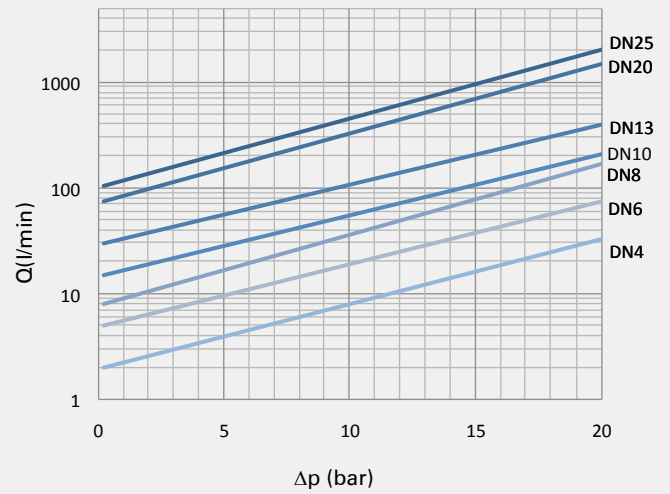

The flow values are measured with usage of hydraulic oil (spissitude 880 kg/m³) and the kinematic viscosity of 35 mm²/s.